

DH-PTZ1C203UE-GN

2MP 3x Starlight IR PTZ Network Camera



- 1/2.8" 2Megapixel STARVIS™ CMOS
- Powerful 3x optical zoom
- Starlight technology
- Max. 25/30fps@1080P
- IVS
- WDR
- H.265 Encoding
- Support PoE
- IR distance up to 20m
- IP66



System Overview

Featuring powerful optical zoom and accurate pan/tilt/zoom performance, the camera provides a wide monitoring range and great detail. The camera delivers 1080P resolution at 25/30fps. The camera is equipped with smooth control, high quality image, and good protection, meeting compact size demands of video surveillance applications.

Functions

Starlight Technology

For challenging low-light applications, Dahua's Starlight Ultra-low Light Technology offers best-in-class light sensitivity, capturing color details in low light down to 0.005 lux. The camera uses a set of optical features to balance light throughout the scene, resulting in clear images in dark environments.

Environmental

Dahua cameras operate in extreme temperature environments, rated for use in temperatures from -30°C to +60 °C (-22 °F to +140°F) with 95% humidity. Subjected to rigorous dust and water immersion tests and certified to the IP66 Ingress Protection rating makes it suitable for demanding outdoor applications.

Protection

The camera allows for 4KV lightning rating, which provides effective protection for both the camera and its structure against lightning.

Interoperability

The camera conforms to the ONVIF (Open Network Video Interface Forum) specifications, ensuring interoperability between network video products regardless of manufacturer.

Wide Dynamic Range

The camera achieves vivid images, even in the most intense contrast lighting conditions, using industry-leading wide dynamic range (WDR) technology. For applications with both bright and low lighting conditions that change quickly, True WDR (120 dB) optimizes both the bright and dark areas of a scene at the same time to provide usable video.

Smart H.265+

Smart H.265+ is the optimized implementation of the H.265 codec that uses a scene-adaptive encoding strategy, dynamic GOP, dynamic ROI, flexible multi-frame reference structure and intelligent noise reduction to deliver high-quality video without straining the network. Smart H.265+ technology reduces bit rate and storage requirements by up to 70% when compared to standard H.265 video compression.

Technical Specification

Camera

Image Sensor	1/2.8" STARVIS™ CMOS
Max. Resolution	2MP
Effective Pixels	1920 (H) × 1080 (V)
ROM	128MB
RAM	256MB
Electronic Shutter Speed	1/3–1/30000s
Minimum Illumination	Color: 0.005Lux@F1.8 B/W: 0.0005Lux@F1.8 0Lux (IR light on)
IR Distance	20m (65.6ft)
IR On/Off Control	Zoom Prio/Manual/SmartIR
IR LED Number	1

Lens

Focal Length	2.7mm–8.1mm			
Aperture	F1.8~F2.7			
Field of View	H: 46.43°–106.79° V: 25.91°–57.88°			
Optical Zoom	3x			
Focus Control	Auto/Semi-Auto/Manual			
Close Focus Distance	0.8m–1.7m			
Iris Control	Fixed Iris			
DORI Distance	Detect	Observe	Recognize	Identify
	101.4m (332.68 ft)	40.6m (133.20 ft)	20.3m (66.60 ft)	10.1m (33.14 ft)

PTZ

Pan/Tilt Range	Pan: 0°–180°; Tilt: -5°–55°
Manual Control Speed	Pan: 6°/s; Tilt: 3°/s

Intelligence

IVS	Tripwire; Intrusion; Object Abandoned/Missing
Advanced Intelligence	Heat Map; Face Detection

Video

Video Compression	H.265; H.264BaselineProfile; H.264MainProfile; H.264HighProfile; MJPEG; H.265 +; H.264+
Streaming Capability	3 Streams
Resolution	1080P (1920×1080); 1.3M (1280×960); 720P (1280×720); D1 (704×576); CIF (352×288)
Video Frame Rate	Main Stream: 1080P/1.3M/720P(1–25/30fps) Sub Stream 1: D1/CIF(1–25/30fps) Sub Stream 2: 720P/D1/CIF(1–25/30fps)
Bit Rate Control	Variable Bit Rate/Constant Bit Rate

Video Bit Rate	H.264: 216Kbps–8192Kbps H.265: 108Kbps–8192Kbps
Day/Night	ICR
BLC	Support
WDR	120dB
HLC	Support
White Balance	Auto/Indoor/Outdoor/Tracking/Manual/Sodium lamp/ Natural/Street lamp
Gain Control	Auto/Manual
Noise Reduction	2D/3D
Motion Detection	Support
Region of Interest (RoI)	Support
Electronic Image Stabilization	Support
Defog	Electronic Defog
Digital Zoom	16x

Audio

Audio Compression	G.711A; G.711Mu; G.726; AAC; MPEG2-Layer2; G.722.1; G.729
Audio In	1
Audio Out	1

Network

Ethernet Port	1 RJ-45 Port 10/100Base-T
Network Protocol	IPv4; IPv6; HTTP; HTTPS; 802.1x; Qos; FTP; SMTP; UPnP; SNMP; DNS; DDNS; NTP; SNMPv1/v2c/ v3(MIB-2); ARP; RTCP; RTSP; RTP; TCP; UDP; IGMP; ICMP; DHCP; PPPoE
Interoperability	ONVIF; CGI
Streaming Method	Unicast / Multicast
User/Host	20 (Total bandwidth 48M)
Edge Storage	FTP; Micro SD card (256G); P2P
Browser	IE7 and newer versions Chrome 42 and older versions Firefox 52 and older versions Safari
Management Software	Smart player Configtool SMART PSS DMSS DSS

Certifications

Certifications	CE: EN55032/EN55024/EN50130-4 FCC: Part15 subpartB, ANSI C63.4- 2014
----------------	---

Electrical

Power Supply	DC12V/1.5A±10% POE (802.3af)
Power Consumption	7W 11W (PTZ, IR light)

Environmental

Operating Conditions	-30°C to +60°C (-22°F to 140°F)
----------------------	---------------------------------

Operating Humidity	≤95% RH
Ingress Protection	IP66; TVS 4000V lightning protection; surge protection
Construction	
Housing Material	Aluminium alloy ADC12
Dimensions	Wall mounted: 195.3mm×90mm×102.7mm (7.69"×3.54"×4.04") Ceiling mounted: 190.8mm×90mm×112.2mm (7.51"×3.54"×4.42")
Weight	Net Weight: 0.9 kg (1.98 lb); Gross Weight: 1.2 kg (2.65 lb)

Dimensions (mm/inch)

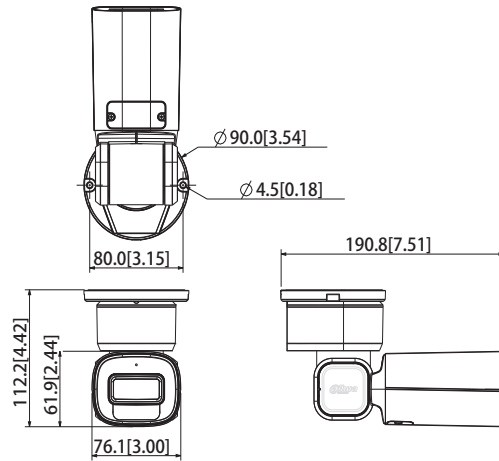
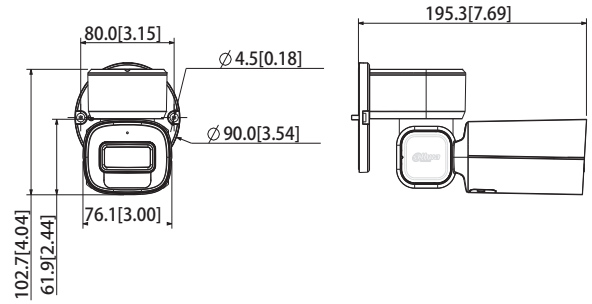

Ordering Information

Type	Model	Description
2MP PTZ Camera	DH-PTZ1C203UE-GN	2MP 3x Starlight IR PTZ Network Camera, WDR, PAL
	DH-PTZ1C203UEN-GN	2MP 3x Starlight IR PTZ Network Camera, WDR, NTSC
	PTZ1C203UE-GN	2MP 3x Starlight IR PTZ Network Camera, WDR, PAL
	PTZ1C203UEN-GN	2MP 3x Starlight IR PTZ Network Camera, WDR, NTSC
Accessories	PFA731	Junction Box (wall-mount)
	DC12V/2A	Power Adapter

Accessories

Optional:



PFA731
Junction Box
(wall-mount)



DC12V/2A
Power Adapter

